

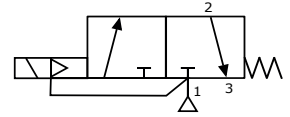

Reflex Solenoid Valve

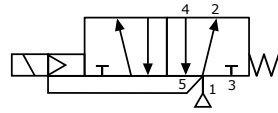

DESCRIPTION

Solenoid valve designed for direct mounting onto 1/4 turn pneumatically operated valve actuators meeting 'NAMUR' standard fixing dimensions. Value engineered for safe area applications.

Body material - Aluminium

FEATURES

- Top face air connection
- 1/4" BSP mains air connection and exhaust ports
- Screwdriver override as standard
- Integrated Exhaust to Spring (ETS) feature in 3/2 position
- Cv = 1.0
- The valve is fitted with a change-over plate that allows the valve to be converted from 3/2 to 5/2 function quickly and easily for spring return and double acting actuators

PRODUCT CODE: **R 2 5 1 8 P**  **S 0** 

COIL

VOLTAGE



SEE BELOW FOR
PRODUCT CODE
DETAILS

Any of the below options that
are not required enter '0' in
relevant box.

Coil

-  **K** MC30 Plug & Socket
-  **L** MC30 Plug & Socket with LED

Standard Voltage

-  **B** 24v DC
-  **R** 24v AC (50/60 Hz)
-  **T** 110v AC (50/60 Hz)
-  **U** 240v AC (50/60 Hz)

* A comprehensive
range of non-standard
voltages available on
request

EXHAUST TO SPRING

In 3/2 function a proportion of clean air exhausting from the actuator is fed back into the spring chamber.

DIMENSIONS (MM)

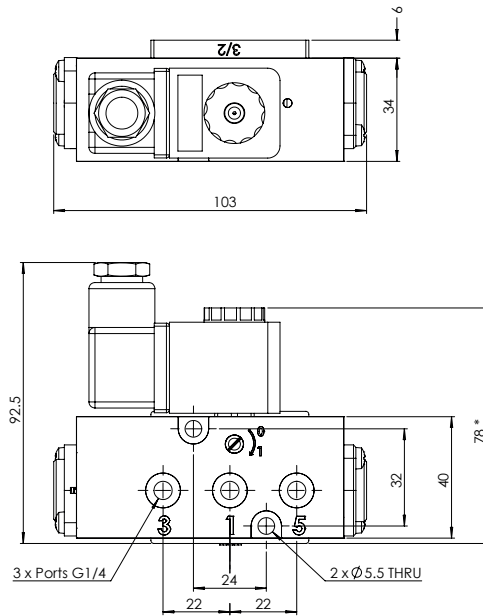

* Minimum height with plug connector rotated through 90 degrees.

MATERIAL SPECIFICATIONS

	STANDARD
Body	Black Anodised Aluminium (Dural)
Spool	Hard Anodised Aluminium PTFE Impregnated
Spacers	Glass Filled Acetal
Seals	Nitrile
Spring	Music Wire
Mounting Screws	Stainless Steel
Change Over Plate and End Caps	Nylon 66 30% Glass Filled
Gasket	Nitrile

VALVE SPECIFICATIONS

	STANDARD
Port Connection Size	1/4" BSP
Working Pressure	3 to 10 bar
Cv Factor	1.0
Flow Rate (at 6 bar with 1 bar pressure drop)	1000 l/min
Maximum Ambient Temperature	+80 °C
Minimum Working Temperature	-20 °C

COIL SPECIFICATIONS

Coil Type	MC 30 Plug & Socket
Area Class	Safe
Area Category	N/A
Ingress Protection	IP65
Cable Entry	PG.9
Ambient Temperature	-20 to +80 °C
Magnetic Wire Class	H
Power Consumption (Nominal)	2.0 Watts (DC) Pull in - 9VA, Holding - 5VA (AC)